

# Product data sheet

Specifications



## TeSys Deca Manual Starter and Protector, magnetic circuit protector, rotary handle, 2.5 A, screw clamp terminals

GV2L07

Product availability: Non-Stock - Not normally stocked in distribution facility

Price\*: 207.00 USD

### Main

Range	TeSys Deca
Product name	TeSys GV2 TeSys Deca
Product or Component Type	Motor circuit breaker
Device short name	GV2L
Device Application	Motor protection
Trip unit technology	Magnetic

### Complementary

poles description	3P
Network type	AC
Utilisation category	Category A IEC 60947-2 AC-3 IEC 60947-4-1 AC-3e IEC 60947-4-1
Network frequency	50/60 Hz IEC 60947-2
Fixing mode	35 mm symmetrical DIN rail clipped Panel screwed with 2 x M4 screws)
Motor power kW	0.75 kW 400/415 V AC 50/60 Hz 1.1 kW 500 V AC 50/60 Hz 1.5 kW 690 V AC 50/60 Hz
Breaking capacity	100 kA Icu 230/240 V AC 50/60 Hz IEC 60947-2 100 kA Icu 400/415 V AC 50/60 Hz IEC 60947-2 100 kA Icu 440 V AC 50/60 Hz IEC 60947-2 100 kA Icu 500 V AC 50/60 Hz IEC 60947-2 4 kA Icu 690 V AC 50/60 Hz IEC 60947-2
[Ics] rated service short-circuit breaking capacity	100 % 230/240 V AC 50/60 Hz IEC 60947-2 100 % 400/415 V AC 50/60 Hz IEC 60947-2 100 % 440 V AC 50/60 Hz IEC 60947-2 100 % 500 V AC 50/60 Hz IEC 60947-2 100 % 690 V AC 50/60 Hz IEC 60947-2
Control Type	Rotary handle
Line Rated Current	2.5 A
Magnetic tripping current	33.5 A
[Ith] conventional free air thermal current	2.5 A IEC 60947-4-1
[Ue] rated operational voltage	690 V AC 50/60 Hz IEC 60947-2

Price is "List Price" and may be subject to a trade discount – check with your local distributor or retailer for actual price.

<b>[Ui] rated insulation voltage</b>	690 V AC 50/60 Hz IEC 60947-2
<b>[Uimp] rated impulse withstand voltage</b>	6 kV IEC 60947-2
<b>Suitability for isolation</b>	Yes IEC 60947-1 § 7-1-6
<b>Power dissipation per pole</b>	1.8 W
<b>Mechanical durability</b>	100000 cycles
<b>Electrical durability</b>	100000 cycles AC-3 415 V In 100000 cycles AC-3e 415 V In
<b>Rated duty</b>	Continuous IEC 60947-4-1
<b>Tightening torque</b>	15.05 lbf.in (1.7 N.m) screw clamp terminal
<b>Width</b>	1.8 in (45 mm)
<b>Height</b>	3.5 in (89 mm)
<b>Depth</b>	3.8 in (97 mm)
<b>Net Weight</b>	0.73 lb(US) (0.33 kg)
<b>color</b>	Dark grey

## Environment

<b>Standards</b>	EN/IEC 60947-2 EN/IEC 60947-4-1 UL 60947-4-1 CSA C22.2 No 60947-4-1
<b>Product Certifications</b>	CCC UL CSA EAC LROS (Lloyds register of shipping) BV RINA DNV-GL UKCA IECEE CB Scheme
<b>IK degree of protection</b>	IK04
<b>IP degree of protection</b>	IP20 IEC 60529
<b>Climatic withstand</b>	IACS E10
<b>Ambient Air Temperature for Storage</b>	-40...176 °F (-40...80 °C)
<b>Fire resistance</b>	1760 °F (960 °C) IEC 60695-2-11
<b>Ambient air temperature for operation</b>	-4...140 °F (-20...60 °C)
<b>Mechanical robustness</b>	Shocks 30 Gn for 11 ms Vibrations 5 Gn, 5...150 Hz
<b>Operating altitude</b>	6561.68 ft (2000 m)

## Ordering and shipping details

<b>Category</b>	US10I1122367
<b>Discount Schedule</b>	0111
<b>GTIN</b>	3389110213249
<b>Returnability</b>	No
<b>Country of origin</b>	TH

## Packing Units

<b>Unit Type of Package 1</b>	PCE
<b>Number of Units in Package 1</b>	1
<b>Package 1 Height</b>	1.890 in (4.800 cm)
<b>Package 1 Width</b>	3.740 in (9.500 cm)
<b>Package 1 Length</b>	4.055 in (10.300 cm)
<b>Package 1 Weight</b>	11.287 oz (320.000 g)
<b>Unit Type of Package 2</b>	S02
<b>Number of Units in Package 2</b>	20
<b>Package 2 Height</b>	5.906 in (15.000 cm)
<b>Package 2 Width</b>	11.811 in (30.000 cm)
<b>Package 2 Length</b>	15.748 in (40.000 cm)
<b>Package 2 Weight</b>	14.535 lb(US) (6.593 kg)
<b>Unit Type of Package 3</b>	P06
<b>Number of Units in Package 3</b>	320
<b>Package 3 Height</b>	29.528 in (75.000 cm)
<b>Package 3 Width</b>	23.622 in (60.000 cm)
<b>Package 3 Length</b>	31.496 in (80.000 cm)
<b>Package 3 Weight</b>	250.203 lb(US) (113.490 kg)

## Contractual warranty

<b>Warranty</b>	18 months
-----------------	-----------

## Sustainability

**Green Premium™ label** is Schneider Electric's commitment to delivering products with best-in-class environmental performance. Green Premium promises compliance with the latest regulations, transparency on environmental impacts, as well as circular and low-CO<sub>2</sub> products.

**Guide to assessing product sustainability** is a white paper that clarifies global eco-label standards and how to interpret environmental declarations.

[Learn more about Green Premium >](#)

[Guide to assess a product's sustainability >](#)



Transparency RoHS/REACH

## Well-being performance

Mercury Free

Rohs Exemption Information Yes

## Certifications & Standards

Reach Regulation [REACH Declaration](#)

Eu Rohs Directive Compliant with Exemptions

China Rohs Regulation [China RoHS declaration](#)  
Product out of China RoHS scope. Substance declaration for your information.

Environmental Disclosure [Product Environmental Profile](#)

Weee The product must be disposed on European Union markets following specific waste collection and never end up in rubbish bins.

Circularity Profile [End of Life Information](#)

California Proposition 65 WARNING: This product can expose you to chemicals including: Antimony oxide & Antimony trioxide, which is known to the State of California to cause cancer. For more information go to [www.P65Warnings.ca.gov](http://www.P65Warnings.ca.gov)

Performance Curves

**Tripping Curves for GV2L or LE Combined with Thermal Overload Relay LRD or LR2K**  
 Average Operating Times at 20 °C Related to Multiples of the Setting Current

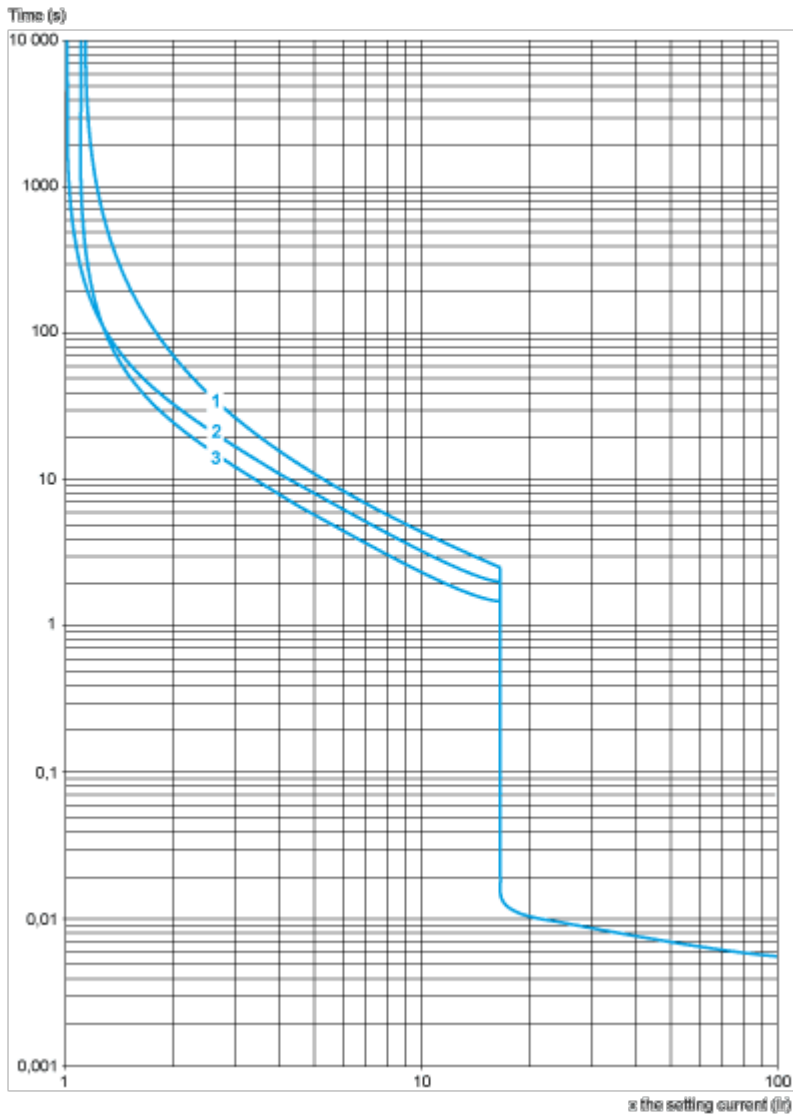

- 1 3 poles from cold state
- 2 2 poles from cold state
- 3 3 poles from hot state

**Current Limitation on Short-Circuit for GV2L and GV2LE Only (3-Phase 400/415 V)**

**Dynamic Stress**

$I_{peak} = f(\text{prospective } I_{sc}) \text{ at } 1.05 U_e = 435 \text{ V}$

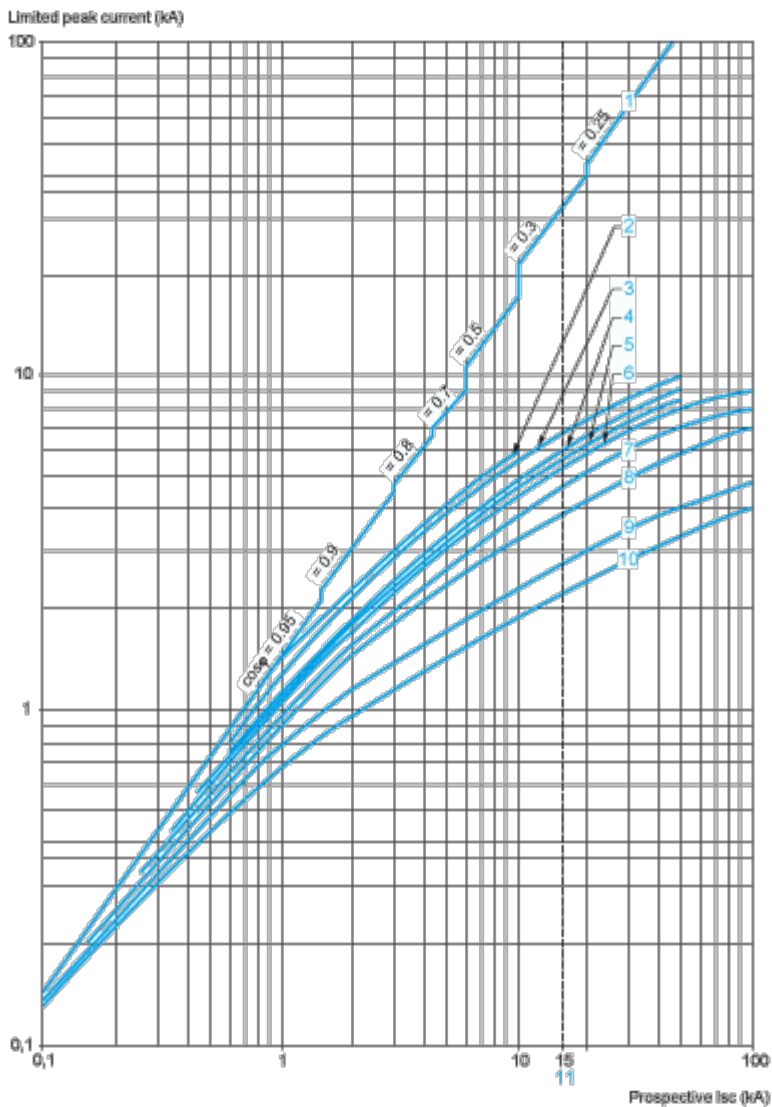

- 1 Maximum peak current
- 2 32 A
- 3 25 A
- 4 18 A
- 5 14 A
- 6 10 A
- 7 6.3 A
- 8 4 A
- 9 2.5 A
- 10 1.6 A
- 11 Limit of rated ultimate breaking capacity on short-circuit of GV2LE (14, 18, 23, and 25 A ratings).

**Current Limitation on Short-Circuit for GV2L and GV2LE + Thermal Overload Relay LRD or LR2K (3-Phase 400/415 V)**

**Dynamic Stress**

$I_{peak} = f(\text{prospective } I_{sc}) \text{ at } 1.05 U_e = 435 \text{ V}$

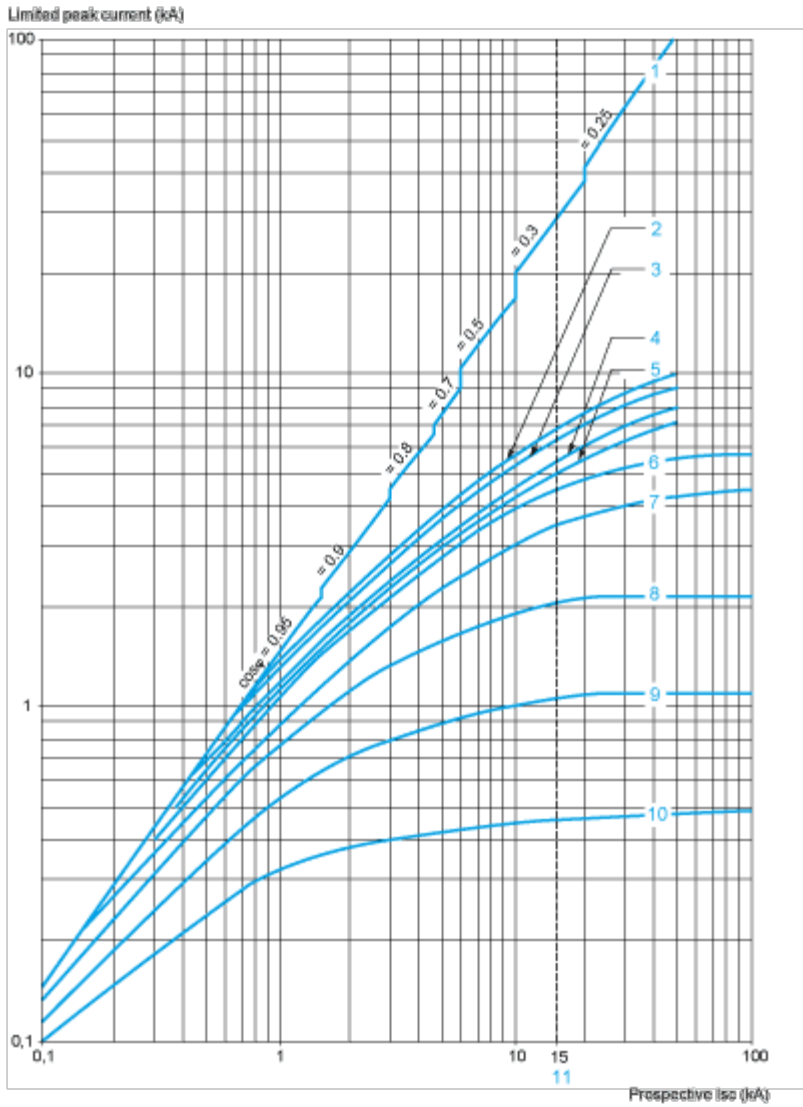

- 1 Maximum peak current
- 2 32 A
- 3 25 A
- 4 18 A
- 5 14 A
- 6 10 A
- 7 6.3 A
- 8 4 A
- 9 2.5 A
- 10 1.6 A
- 11 Limit of rated ultimate breaking capacity on short-circuit of GV2LE (14, 18, 23, and 25 A ratings).

**Thermal Limit on Short-Circuit for GV2L Only**

Thermal Limit in  $kA^2s$  in the Magnetic Operating Zone

Sum of  $I^2dt = f$  (prospective Isc) at  $1.05 U_e = 435 V$

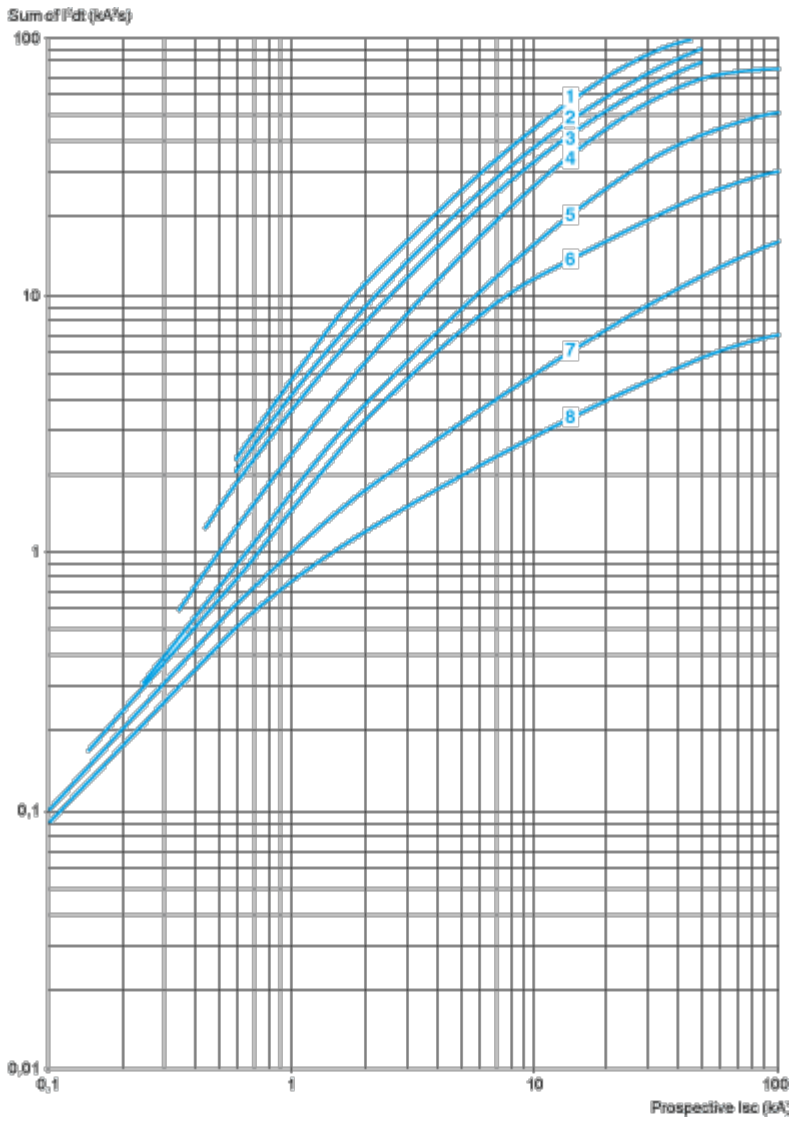

- 1 25 A and 32 A
- 2 18 A
- 3 14 A
- 4 10 A
- 5 6.3 A
- 6 4 A
- 7 2.5 A
- 8 1.6 A

**Thermal Limit on Short-Circuit for GV2L and GV2LE + Thermal Overload Relay LRD or LR2K**

Thermal Limit in kA<sup>2</sup>s in the Magnetic Operating Zone

Sum of I<sup>2</sup>dt = f (prospective Isc) at 1.05 Ue = 435 V



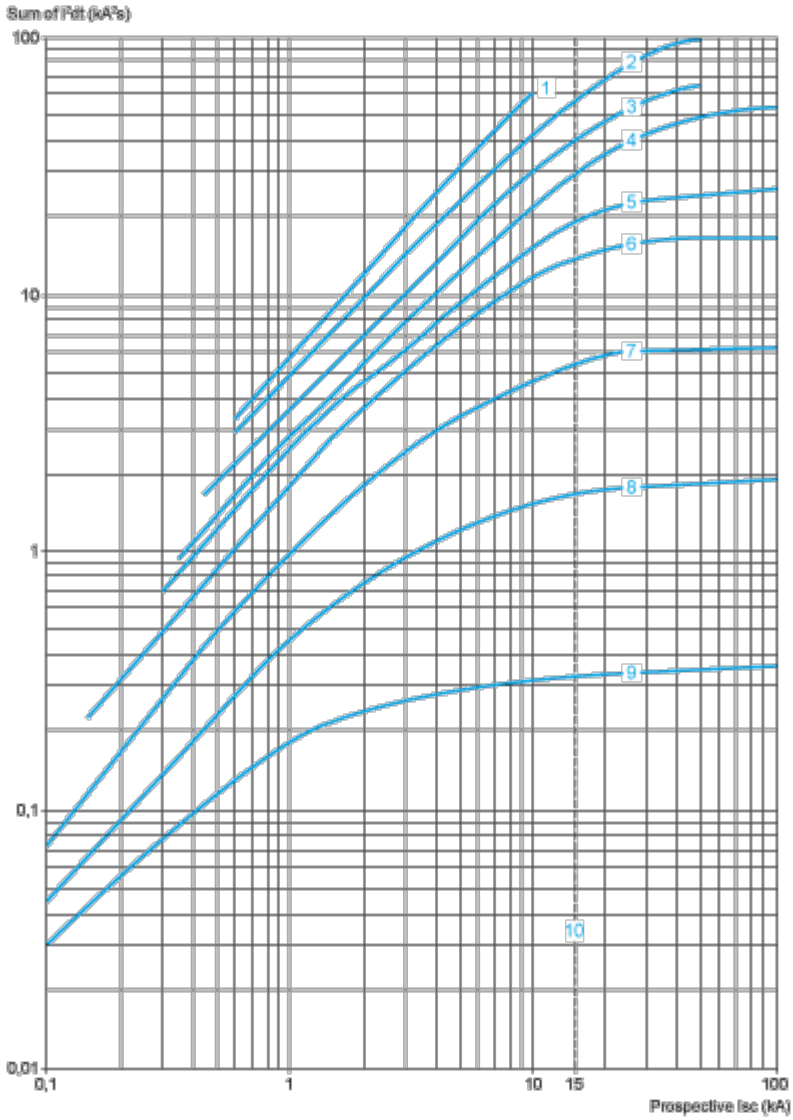

- 1 32 A (GV2LE32)
- 2 25 A and 32 A (GV2L32)
- 3 18 A
- 4 14 A
- 5 10 A
- 6 6.3 A
- 7 4 A
- 8 2.5 A
- 9 1.6 A
- 10 Limit of rated ultimate breaking capacity on short-circuit of GV2 LE (14, 18, 23, and 25 A ratings).

Dimensions Drawings

GV2L

Dimensions

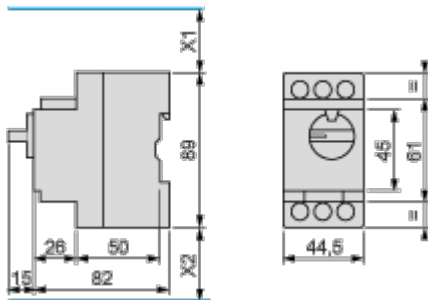

X1 Electrical clearance = 40 mm for  $U_e \leq 415$  V, or 80 mm for  $U_e = 440$  V, or 120 mm for  $U_e = 500$  and  $690$  V.  
 X2 = 40 mm.

GVAD, AM, AN, AU, AS

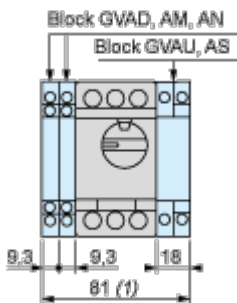

1 Maximum

GV2AK00

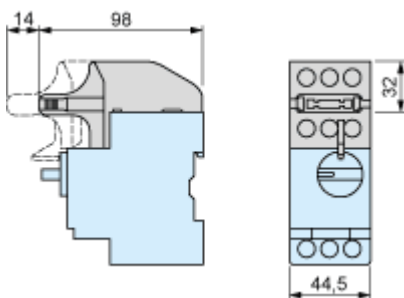

Mounting

On rail AM1 DE200, AM1 ED200 (35 x 15)

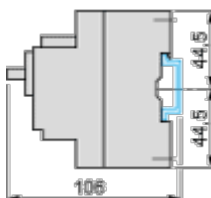

Panel mounted

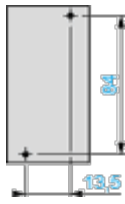

On pre-slotted mounting plate AM1 PA

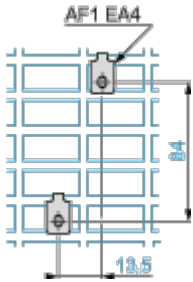

Adapter Plate GK2AF01

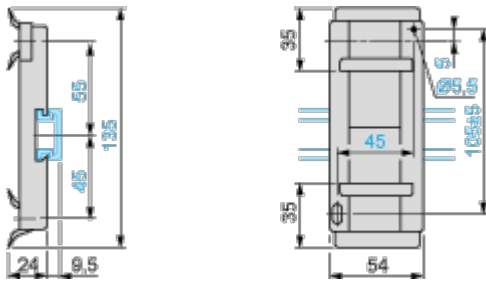

7.5 mm Height Compensation Plate GV1F03

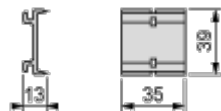

Mounting

Mounting of External Operator GV2APN01, GV2APN02 or GV2APN04 for Motor Circuit Breakers GV2L

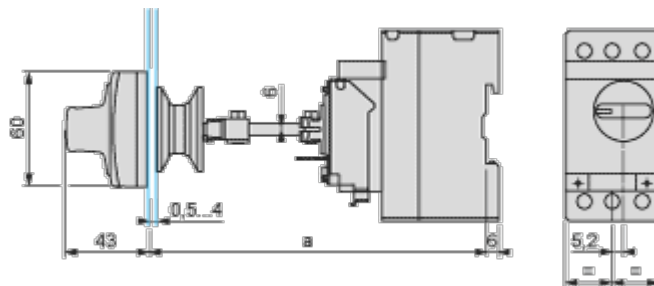

Door cut-out

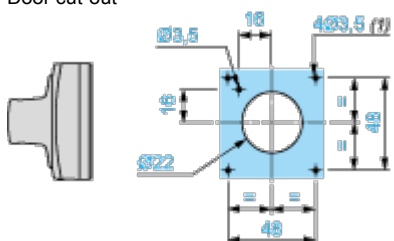

(1) For IP65 only.

Mounting of External Operator GVAPH02 for Motor Circuit Breakers GV2L

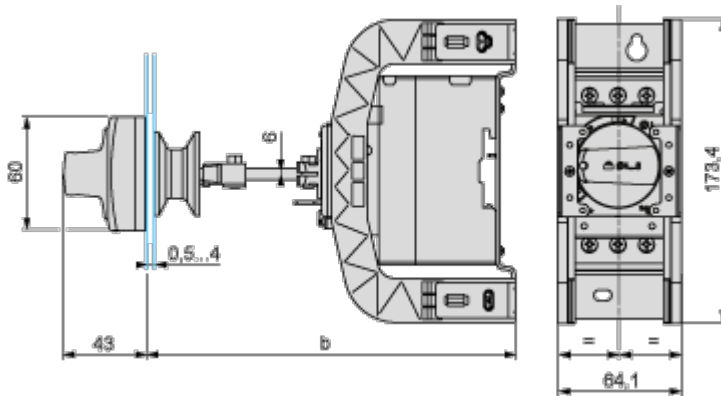

	b	
	Minimum	Maximum
GV2 APN <sub>..</sub> + GV APH02	151	250
GV2 APN <sub>..</sub> + GV APH02 + GV APK11	250	445

Door cut-out

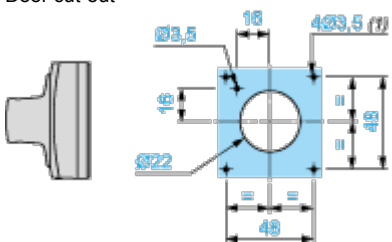

(1) For IP65 only.

GV2L and GV2LE

Sets of busbars GV2G445, GV2G454, GV2G472, with terminal block GV2G05

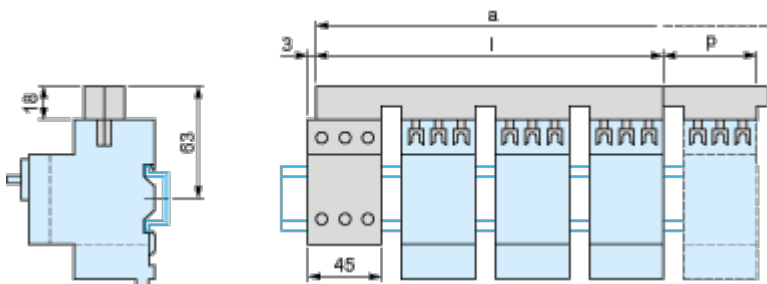

	l	p
GV2G445 (4 x 45 mm)	179	45
GV2G454 (4 x 54 mm)	206	54
GV2G472 (4 x 72 mm)	260	72

Number of tap-offs	a			
	5	6	7	8
GV2G445	224	269	314	359
GV2G454	260	314	368	422
GV2G472	332	404	476	548

Sets of Busbars for GV2L and GV2LE

Sets of busbars GV2G... with terminal block GV1G09

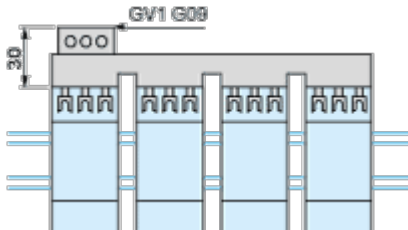

Sets of busbars GV2G245, GV2G254, GV2GR272

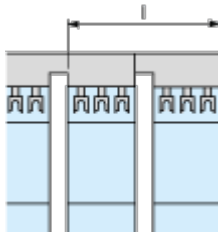

	l
GV2G245 (2 x 45 mm)	89
GV2G254 (2 x 54 mm)	98
GV2G272 (2 x 72 mm)	116

Set of busbars GV2G554

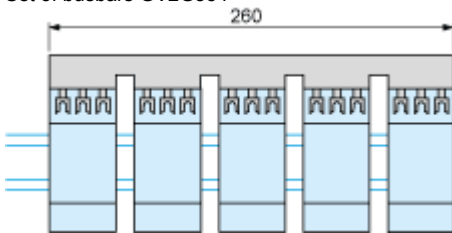

Sets of busbars GV2G345 and GV2G354

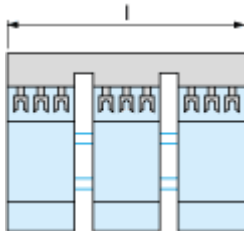

	l
GV2G345 (3 x 45 mm)	134

	I
GV2G354 (3 x 54 mm)	152

## Connections and Schema

---

GV2L••

